

MOULDINGS CHART

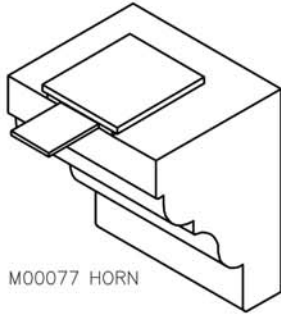

M00077 HORN

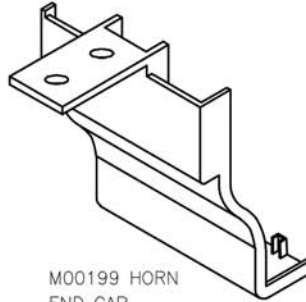

M00199 HORN
END CAP

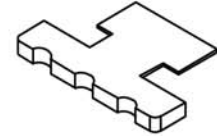

M00079 COVER ENDCAPS
FOR P10124



M00182 SASH BLOCK

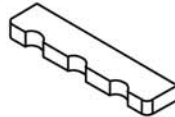

M00078 COVER ENDCAPS
FOR P10124

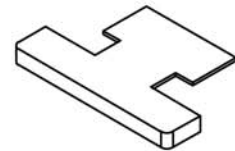

M00192 COVER ENDCAPS
FOR P10124

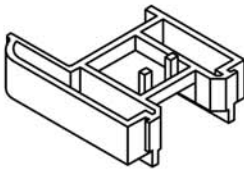

M00122 VERTICAL SLIDER ENDCAP
FOR MECHANICAL JOINT FIXING

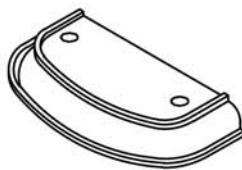

M00189 CAM CATCH PACKER
FOR USE WITH CALDWELL
PE 520 & 521 CAM CATCHES.

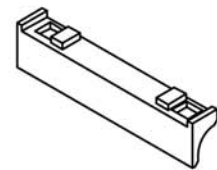

M00091 KEEP PACKER
FOR USE WITH CALDWELL
KEEPS ONLY.



G00066 GLAZING GASKET



G00042 SLIDER SEAL



G00091 BASE SEAL